

Star Beam (SB)

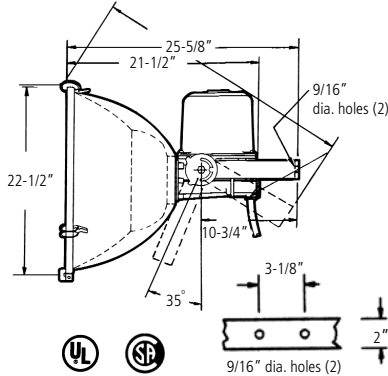

Suitable for wet locations
Lamp not included



Solid Line - NEMA Heavy Duty
Dotted Line - NEMA General Purpose
Standard Product includes outer hull.
-LH option denotes Less Outer Hull

Star Beam Specification

Star Beam sports lighting floodlight (specify) general purpose heavy duty aluminum outer housing. Totally weatherproof construction, shall accommodate a 250, 400 or 1,000 watt mogul base high pressure sodium lamp or a 250, 400, 1,000 or 1,500 watt mogul base metal halide lamp. Available with (specify) 120, 208, 240, 277, 347, 480 volt or 4MT (120,208,240,277V), 60Hz ballast. The floodlight shall be completely pre-wired and factory assembled. Floodlight shall be NEMA type 2, 3, 4, 5 or 6 beam spread.

Basic Product Description

Shipped as a complete unit in one carton for ease of installation and servicing. Die cast ballast housing, socket housing and wiring compartment is finned for cooler ballast operation and longer ballast life. Floodlight is finished in all weather bronze polyester powder coating (optional colors are available). Floodlight shall include a weatherproof strain relief bushing, sturdy two hole mounting yoke formed of high strength non-corrosive copper free aluminum, degree quadrant with positive repositioning stop. There shall be a removable beam sight.

Ballast Characteristics

The floodlight shall contain a U.L. recognized High Power Factor, constant wattage auto-transformer type ballast and start and operate the lamp down to -20°F (-30°C) for metal halide and -40°F (-40°C) for high pressure sodium. Mercury vapor lamps may be used in 250, 400, or 1000 watt metal halide fixtures. For availability of 220/240V 50Hz ballasts - consult factory.

Reflector Assembly

The sealed reflector assembly shall include a 21" diameter one-piece spun aluminum electro brite reflector, three quick-release stainless steel latches secure the lens frame to the reflector. The stainless steel lens frame is hinged at the bottom and swings clear for ease of servicing. A one piece high temperature silicone gasket seals the thermal shock, heat resistant, tempered clear glass lens.

Heavy Duty Outer Housing Options

Shall include a heavy-gauge spun aluminum bronze outer hull (standard).
OR
-LH option (Less Hull) for General Purpose (Reflector ONLY)

Ordering Example

Unit	Wattage	NEMA Beam Type	Mounting	Lamp Type	Voltage	Options
SB	8	4	1	H	120	LH
Star Beam	4 - 250	2 - 2 x 2	1-Yoke Mount	H - Metal Halide	120	LH - General Purpose
	6 - 400	3 - 3 x 3		LS - High Pressure Sodium	208	
	8 - 1000	4 - 4 x 4			240	
	9 - 1500	5 - 5 x 5			277	No Suffix - Heavy Duty Outer Hull
		6 - 6 x 6			480	
					4MT- (120, 208, 240, 277V) 347	
					RBH - Remote Ballast	
			Accessories			
			V			
			V* - Visor			
			LS - Lamp Support			
			F - Single Fuse (120,277v)			
			DF - Double Fuse (208, 240, 480v)			
			FB - Filter Breather			
			SC - Stainless Steel Safety Cable			
			RPC - Factory Wired Twist lock photocell receptacle ONLY			
			PE - Twist Lock Photocell			
			3/14/350 - 3 ft. cord. for other length change 3' to length desired			
			UP* - for aiming above horizontal			
			PL* - Polycarbonate Shield			
			POS - Position-Oriented Socket			

*Must be factory installed

Star Beam (SB)

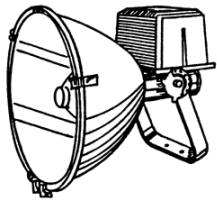

Heavy duty outer housing (standard no suffix)

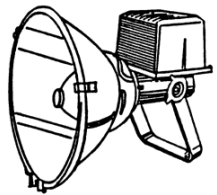

General Purpose ("LH") Less Outer Housing

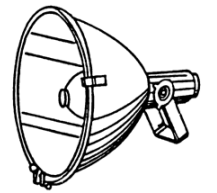

Remote Ballast ("RBH")

Sports Lighting Applications

Baseball, football, softball and soccer field, tennis courts, driving ranges and other athletic fields and stadiums.

Specification Features

- Stainless steel hardware and lens ring.
- Thermal shock and impact resistant tempered glass lens.
- Copper-free aluminum yoke.
- Completely factory assembled. No field assembly required.
- Die cast ballast & socket housing.
- Positive repositioning stop.
- Porcelain mogul base socket.

Effective Projected Area

EPA = 2.35 SQ. FT.
Weight = 50-67 lbs

Cord Grip for #12, #14, or #16 cable.

3' #14/3 SO Cord is available, ordering suffix 3/14/3SO.
For other cord lengths replace 3 with length required. Factory installed.

Accessories (Must be ordered with fixture)

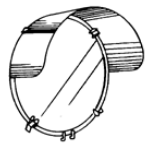

Visor "V"



Polycarbonate Shield "PL"



Single Fuse "F"
Double Fuse "DF"



Lamp Support "LS"

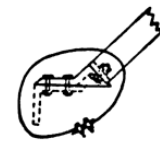

1/8" Stainless Steel Cable "SC"

Mounting Brackets

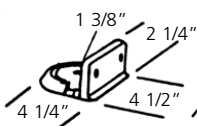

SB-2*

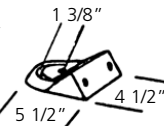

SB-245*

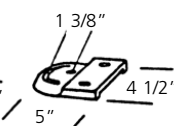

SB-290*

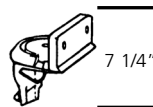

SB-3

Wall or 2" Pipe Clamp Mount. Supplied with 2 "U" Bolts



SB-5

Fits 2" to 2 1/2" pipe (2 3/8" to 2 7/8" OD)

*For Horizontal Yoke Mounting, 180° Adjustment - Includes (2) 1/2" Bolts



Star Beam (SB)

Photometrics

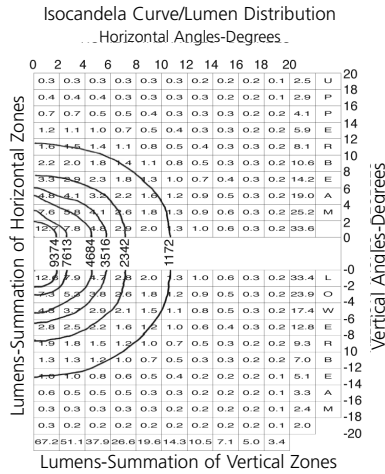
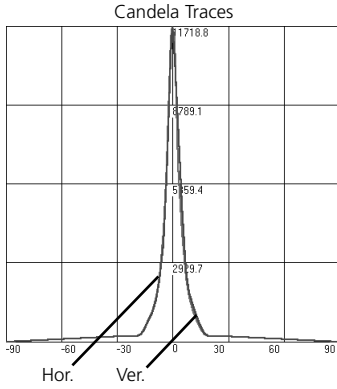

Fixture: SB-821H
Lamp: 1000 or 1500 Watt Metal Halide

IES Type 2H X 2V
Max Candela 11718
Hor Beam Angle (50%) 7.2 deg
Ver Beam Angle (50%) 7.7 deg
HOR Field Angle (10%) 21.6 deg
VER Field Angle (10%) 22.5 deg
Field Lumens 336
Field Efficiency 33.6%

Candela & Lumen values are based on 1,000 lamp lumens. For other lamp lumen ratings, multiply candela and lumen values by the number: Lumens divided by 1,000.

Per 1,000 Lamp Lumens

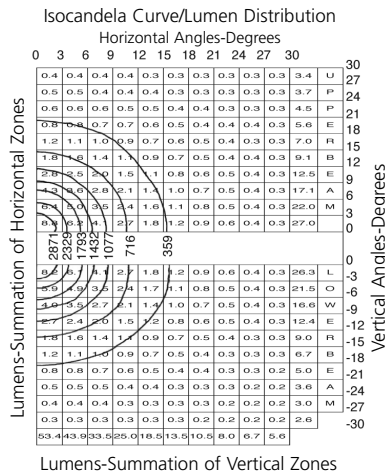
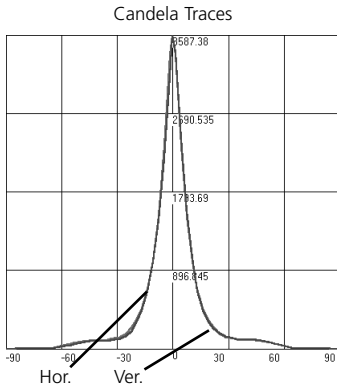

Fixture: SB-831H
Lamp: 1000 or 1500 Watt Metal Halide

IES Type 3H X 3V
Max Candela 3587
Hor Beam Angle (50%) 13.0 deg
Ver Beam Angle (50%) 12.9 deg
HOR Field Angle (10%) 37.4 deg
VER Field Angle (10%) 36.6 deg
Field Lumens 311
Field Efficiency 31.1%
Total Lumens 618
Total Efficiency 61.8%

Candela & Lumen values are based on 1,000 lamp lumens. For other lamp lumen ratings, multiply candela and lumen values by the number: Lumens divided by 1,000.

Per 1,000 Lamp Lumens

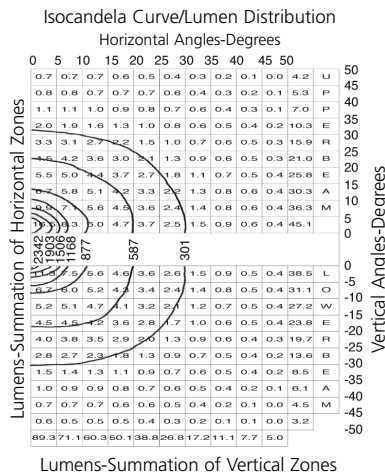
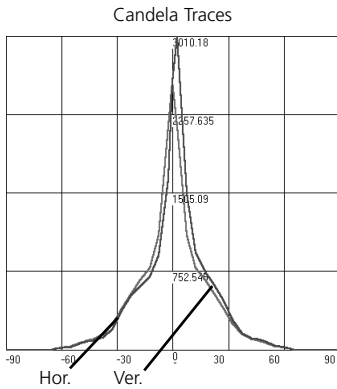

Fixture: SB-841H
Lamp: 1000 or 1500 Watt Metal Halide

IES Type 4H X 4V
Max Candela 3010
Hor Beam Angle (50%) 11.2 deg
Ver Beam Angle (50%) 10.5 deg
HOR Field Angle (10%) 60.7 deg
VER Field Angle (10%) 61.3 deg
Field Lumens 558
Field Efficiency 55.8%
Total Lumens 774
Total Efficiency 77.4%

Candela & Lumen values are based on 1,000 lamp lumens. For other lamp lumen ratings, multiply candela and lumen values by the number: Lumens divided by 1,000.

Per 1,000 Lamp Lumens



Star Beam (SB)

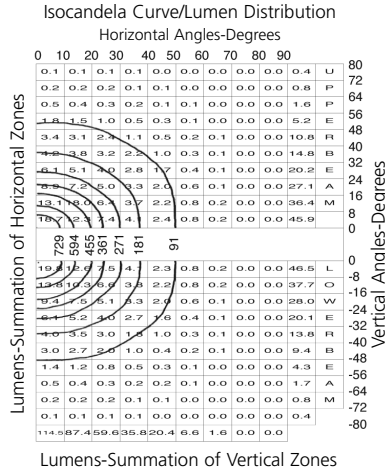
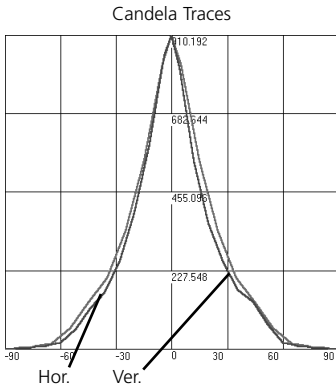

Fixture: SB-851H
Lamp: 1000 or 1500 Watt Metal Halide

IES Type	6H X 5V
Max Candela	910
Hor Beam Angle (50%)	38.9 deg
Ver Beam Angle (50%)	33.7 deg
HOR Field Angle (10%)	101.9 deg
VER Field Angle (10%)	97.2 deg
Field Lumens	591
Field Efficiency	59.1%
Total Lumens	650
Total Efficiency	65.0%

Candela & Lumen values are based on 1,000 lamp lumens. For other lamp lumen ratings, multiply candela and lumen values by the number: Lumens divided by 1,000.

Per 1,000 Lamp Lumens

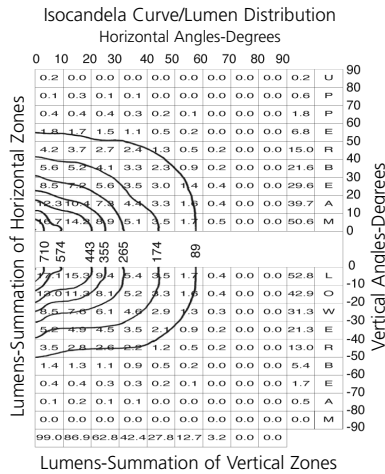
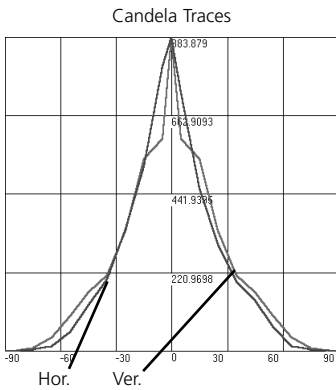

Fixture: SB-861H
Lamp: 1000 or 1500 Watt Metal Halide

IES Type	6H X 6V
Max Candela	883
Hor Beam Angle (50%)	39.9 deg
Ver Beam Angle (50%)	35.6 deg
HOR Field Angle (10%)	113.3 deg
VER Field Angle (10%)	102.7 deg
Field Lumens	609
Field Efficiency	60.9%
Total Lumens	670
Total Efficiency	67.0%

Candela & Lumen values are based on 1,000 lamp lumens. For other lamp lumen ratings, multiply candela and lumen values by the number: Lumens divided by 1,000.

Per 1,000 Lamp Lumens

For further information consult factory

